

Alberta Provincial Achievement Testing

Including French Immersion Subjects

Parent Guide

GRADE
6

we encourage
encourager

Alberta  Government

Copyright 2017, the Crown in Right of Alberta, as represented by the Minister of Education, Alberta Education, Provincial Assessment Sector, 44 Capital Boulevard, 10044 108 Street NW, Edmonton, Alberta T5J 5E6, and its licensors. All rights reserved.

Special permission is granted to **Alberta Educators only** to reproduce, for educational purposes and on a non-profit basis, parts of this document that do **not** contain excerpted material.

Excerpted material in this document **shall not** be reproduced without the written permission of the original publisher (see credits, where applicable).

Contents

<i>Questions Frequently Asked About the Achievement Testing Program</i>	2
<i>Test Descriptions and Sample Questions</i>	7
<i>English Language Arts</i>	7
Test Description.....	7
Sample Questions	8
<i>French Language Arts</i>	9
Test Description	9
Sample Questions	10
<i>Mathematics / Mathématiques</i>	11
Test Description – <i>Part A</i>	11
Test Description – <i>Part B</i>	11
Sample Questions – <i>Part A</i>	12
Sample Questions – <i>Part B</i>	14
<i>Science / Sciences</i>	16
Test Description.....	16
Sample Questions	16
<i>Social Studies / Études Sociales</i>	18
Test Description	18
Sample Questions	18
<i>Answers to Sample Questions</i>	19
<i>Contacts</i>	19
<i>Appendix</i>	20
New French Spelling	20

Questions Frequently Asked About the Achievement Testing Program

Each year, children in Grade 6 write provincial achievement tests in language arts, mathematics, science, and social studies. Students who are registered in French immersion programs write a French form of the mathematics, science, and social studies tests in addition to the French Language Arts and English Language Arts tests. Children in Grade 9 also write achievement tests. As their children prepare to write achievement tests, parents often ask the following questions about the Achievement Testing Program.

What are the purposes of the achievement tests?

The purposes of the achievement tests are to determine how well students are learning what they are expected to learn, to inform Albertans about students' achievement relative to provincial standards, and to assist schools, school authorities, and the province in monitoring and improving student learning.

Who is expected to write the tests?

All students registered in grades 6 and 9 or those in their sixth or ninth year of schooling are expected to write the tests for their grades.

What tests are administered and when?

Achievement tests are administered to students registered in Grade 6 as follows:

Subject	Duration	Month
English Language Arts	<i>Part A: Writing</i> 120 min	May
	<i>Part B: Reading</i> 60 min	June
French Language Arts (immersion students)	<i>Part A: Writing</i> 120 min	May
	<i>Part B: Reading</i> 60 min	June
Mathematics/ Mathématiques	<i>Part A</i> 15 min	June
	<i>Part B</i> 60 min	
Science/Sciences	60 min	June
Social Studies/Études Sociales	60 min	June

What do the achievement tests assess?

Alberta's achievement tests are aligned with the provincial programs of study and with authorized learning and teaching resources. No single test can assess everything. The achievement tests address only those learning outcomes that can be readily assessed by a paper-and-pencil test. The clearest picture of students' growth and development is gained when a wide variety of assessment information is considered. The achievement tests provide part of the picture. In addition, classroom teachers use many different assessment strategies throughout the school year to gain information about what students are learning.

How are achievement tests developed?

Classroom teachers from across the province are involved at every stage of the test development and implementation process, including:

- writing, revising, and reviewing questions,
- administering field tests,
- validating test forms,
- validating French translations,
- validating scoring guides,
- confirming standards,
- administering the tests, and
- marking students' written responses.

What are test accommodations?

Alberta Education provides alternative test formats and/or administration conditions for students with special test-writing needs in order to allow these students to do their best. Test accommodations may include Braille or large-print formats, sign language, use of a reader or scribe, and taped responses. Students who regularly use aids of this type in the classroom to support their learning may make use of these accommodations when writing one or more of their achievement tests.

How can parents help their children prepare for the tests?

It is important that children feel relaxed and comfortable when they write any test, including achievement tests. Children’s feelings about a test are very much influenced by what adults close to them say about those tests. Parents can be of most help to their children by encouraging them to relax and do their best, just as they would when writing any test.

How can teachers prepare their students for writing the tests?

Alberta Education discourages test rehearsal and coaching. Achievement tests are like any other test students would normally write. The best preparation for students to write the provincial achievement tests is effective instruction based on the full range of learning outcomes in the Alberta programs of study.

How are the achievement tests marked?

All achievement tests, except the language arts writing tests, are machine scored. The written-response component of the language arts test is marked centrally, in July, by classroom teachers who have been nominated by their superintendents. These teachers are trained by and work under the supervision of Alberta Education staff.

Alberta Education encourages teachers to mark achievement tests using the scoring guides and exemplars that are provided to them each year. Locally awarded marks on the language arts written-response tests that are submitted to Alberta Education will be used as the first reading of a student’s response. The papers will then be marked centrally as the second reading. Both marks contribute to the student’s final mark. In the event of a discrepancy between the two marks, papers will receive a third reading, which will determine the final mark that the paper is awarded. In this way, valid and reliable individual and group results can be reported. Papers that are not marked locally by teachers will be marked centrally only once.

Teachers are given answer keys for each multiple-choice and numerical-response achievement test, and they are expected to mark the tests and report the preliminary results to parents in June.

Although no single test can provide a comprehensive picture of a student’s achievement, when used in conjunction with more information gained from various classroom assessments, preliminary results can assist parents in more timely and better understanding of their child’s achievement.

How should achievement test results be communicated and used?

Each school and school authority receives a detailed report of its results. A school also receives electronically, through the secure extranet site, two copies of a student’s Individual Student Profile (ISP). In late September, one copy of the ISP is to be placed in the student’s permanent file and the other copy is to be forwarded to the student’s parents or guardians (see samples on pages 5 and 6).

School staff, in consultation with their school council, should look at the school report to see what patterns and trends are evident in the results and to determine how the school’s programs might be improved. The principal, teachers, parents, and community can look at these results in relation to past results, along with school and district assessments and other information about students and programs. They can use this information to provide the best possible learning opportunities for their students.

Similarly, it is helpful if the school board and the jurisdiction look at the school authority report to see how district-wide programs can be improved for students. It is also important for Alberta Education to examine the provincial results to see whether changes are needed in provincial programs or policies.

Used in these ways, the test results support continuous improvement in program planning and in teaching. This, in turn, helps to ensure that as many students as possible achieve provincial standards.

How should school councils use achievement test results?

In collaboration with the school staff, a school council should review the achievement test results. Questions such as the following may serve as a starting point:

- What are the strengths of our school?
- What are the areas requiring growth?
- What factors could be contributing to our school’s performance?
- What trends in achievement test results can we identify for our school over the past several years?
- What are our local achievement targets for this year?
- What plans can we develop to address the areas requiring growth and to help students to do their best?

Should schools be ranked according to their results on provincial achievement tests?

Alberta Education **does not support** comparisons of schools or authorities based on achievement test scores. Rather, in evaluating a school, people should consider a variety of factors that are relevant to that school. The department emphasizes the importance of provincial standards, local targets, and past performance as the basis for examining the test results and planning instructional programs.

Grade 6 Achievement Tests – June 2017

Individual Student Profile

Parent Copy



Student Name:
 Alberta Student Number:
 School of Writing:
 School Authority:

Graph Legend

- Standard of Excellence
- Acceptable Standard
- Below Acceptable Standard
- Student Score

Explanatory Notes

The point on each bar graph indicates the score obtained by the student on the total test and on each of the two components of the test.

The shaded regions indicate the range of scores at the Standard of Excellence (dark grey region), the Acceptable Standard (black region), and below the acceptable standard (light grey region).

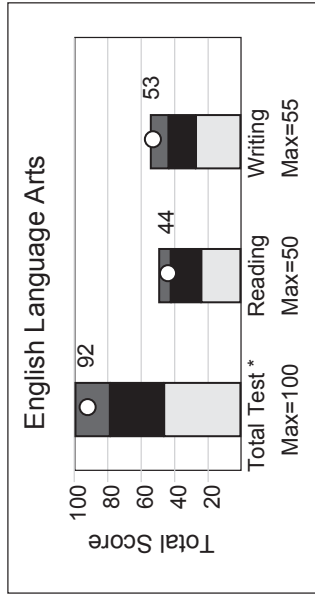

* Reading and Writing are weighted equally in the calculation of the total score.

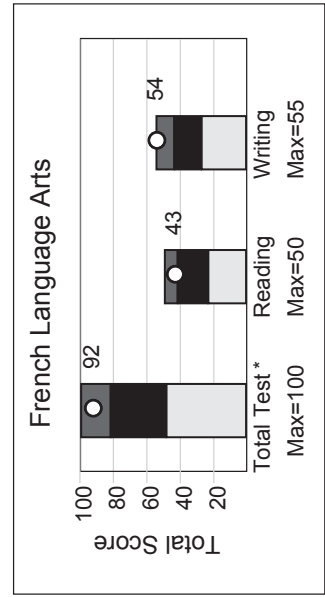
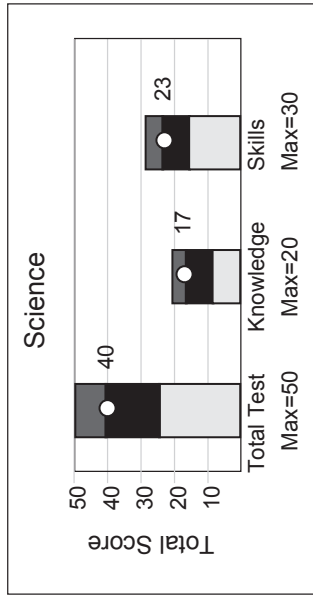
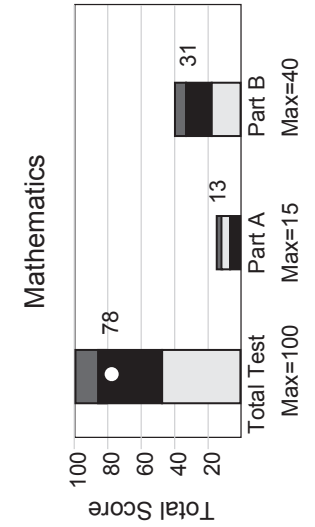
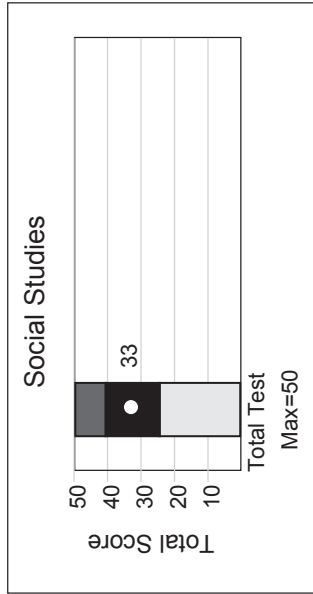

* Reading and Writing are weighted equally in the calculation of the total score.

Grade 6 Achievement Tests – June 2017
Individual Student Profile
Parent Copy



Student Name:
 Alberta Student Number:
 School of Writing:
 School Authority:

Subject	Component	Student's Results			Range of Scores Within Each Standard ¹	
		Score	Standard Achieved	Acceptable Standard	Standard of Excellence	
English Language Arts	Total Test ²	92/100	Excellence	48-77	78-100	
	Reading Writing	44/50 53/55	Excellence Excellence	23-37 28-43	38-50 44-55	
Mathematics	Total Test ³	78/100	Acceptable	46-84	85-100	
	Part A Part B	13/15 31/40	Excellence Acceptable	8-12 18-33	13-15 34-40	
Social Studies	Total Test ³	33/50	Acceptable	24-40	41-50	
Science	Total Test	40/50	Acceptable	24-40	41-50	
	Knowledge Skills	17/20 23/30	Excellence Acceptable	8-15 16-24	16-20 25-30	
French Language Arts	Total Test ²	92/100	Excellence	49-81	82-100	
	Reading Writing	43/50 54/55	Excellence Excellence	24-41 28-43	42-50 44-55	

The table above provides the student's scores for each subject and for the components of that subject. Also included is the range of scores that define each standard.

- ¹ These standards reflect provincial expectations.
- ² Reading and Writing reporting categories are weighted equally in the calculation of the total score for English Language Arts and French Language Arts.
- ³ Provincial standards are only set on the total test.

Additional information regarding the results of your school and school authority, as well as provincial results, are available on the Alberta Education website.
 For further explanation of achievement test results, contact Nicole Lamarre, Director – Provincial Achievement Testing Program (email to: Nicole.Lamarre@gov.ab.ca), Provincial Assessment Sector, or call 780-427-0010 or toll free at 310-0000.

Test Descriptions and Sample Questions

The Grade 6 achievement tests are designed to reflect the learning outcomes that are prescribed in provincial programs of study, and to assess the achievement of these outcomes. More information about these provincial programs of study is available in [My Child's Learning: A Parent Resource](#).

Descriptions of the Grade 6 achievement tests and sample questions have been included to give you a first-hand look at what provincial achievement tests are all about. We have reduced the print size and changed the layout of the questions to fit the limited space available in this guide.

English Language Arts

Test Description

Part A: Writing consists of two writing assignments—one narrative and one functional—developed to be completed in two hours; however, students may have up to 4 hours to complete the test plus an additional 30 minutes should they need it. For the first 10 minutes of the test time, students have time to discuss both assignments with classmates, in groups of two to four, or to think alone about the writing prompts. Students will engage in this discussion time without teacher participation. During this discussion time, students may record their ideas on the planning pages provided in the test booklet. The allotted test time provides students with time for discussion, planning, drafting, and revising of both the narrative and functional writing. Students may do their writing using a computer. They may use commercially published dictionaries, bilingual dictionaries, and thesauri **only** when completing *Part A: Writing*.

Part B: Reading consists of 50 multiple-choice questions based on reading selections from fiction, nonfiction, drama, poetry, and visual media. Students record their answers on a separate, machine-scorable answer sheet. The test is developed to be completed in 60 minutes; however, students have up to 2 hours to complete the test plus an additional 30 minutes should they need it. Students are **not** allowed to use a dictionary, a thesaurus, or other reference material when writing *Part B: Reading*.

For more information, see the [Grade 6 English Language Arts Subject Bulletin](#).

Sample Questions

Part B: Reading

I. Read the excerpt from an article below and answer questions 1 to 3.

from SNOW EATER

It is 7:15 on a dark February morning when five players from the Lethbridge Hurricanes hockey team arrive at the Sixteenth Street outdoor rink. The team had practiced here
5 yesterday in arctic temperatures, but the wind is pleasantly warm this morning as they meet one last time to polish their plays for tonight’s game. But one look at the rink tells them there will be no practice today. At least two inches of
10 water cover the slushy ice. By the end of the day, the rink will be a pool.

What’s happening?

People who live near the Rocky Mountains in southern Alberta, Canada, often say, “If the
15 weather is too cold for you, just wait a few minutes.” Winter temperatures can be -34°C with enough snow to make a skier’s paradise, but a chinook will change that in no time.

A chinook is a warm, dry wind that blows
20 eastward from the Pacific Ocean, over the Rocky Mountains, and across the North American prairie. It can quickly raise temperatures by tens of degrees. *Chinook* is actually a First Nations word meaning “snow eater,” for in
25 a chinook’s path, snow rapidly disappears.

Winds similar to the chinook are called *zonda* in Argentina, *koembang* in Java, *puelche* in the Andes, Santa Ana in California, and
30 *foehn* in Europe. Chinooks occur often over the western plains of North America, but they are most common in the “chinook belt” of southwestern Alberta, where one winter may include up to 30 chinook days. This part of
35 Canada has ideal geographical conditions for a chinook: a warm ocean nearby, prevailing westerly winds, mountains, and plains.

Alberta’s chinook begins in the Pacific Ocean. Warm, moist winds originate there, then sweep across British Columbia and up the
40 western slopes of the Rockies. As the air rises, it expands and cools. Cold air cannot hold as much moisture as warm air, so the moisture falls as rain or snow in the Rockies and west of them.

The now dry air rushes down the eastern
45 side of the mountains, picking up speed as heavy, cool air pushes on it from above. The compression causes rapid warming, much like air heated in a bicycle pump. Temperatures
50 may rise as much as 25°C in five minutes! As the wind sweeps over the prairie, it pushes the cloud cover into an arched band moving eastward across the sky and searches for

moisture to absorb, which it finds in snow.

55 Prairie dwellers have depended on the chinook’s warmth throughout history. When early settlers saw the chinook arch, they quickly collected snow in barrels and tubs, because the melted snow would be a convenient water supply.
60 Today’s farmers and ranchers in southern Alberta still count on chinooks to enable them to keep their cattle and horses outside during the winter. The thaw helps animals find food hidden under the snow, and occasional warm spells make
65 winter more livable.

With today’s meteorology, we can explain and even predict chinooks. But because the chinook was so difficult for early inhabitants of Alberta to understand, much folklore grew
70 up around it.

Dolores Andressen

1. In line 24, the phrase “snow eater” is in quotation marks to indicate
 - A. a slang expression
 - B. translated words
 - C. spoken words
 - D. a title
2. According to the article, in North America, chinooks take place most often
 - A. in California
 - B. over the Pacific Ocean
 - C. in southwestern Alberta
 - D. on the western slopes of the Rockies
3. According to the article, folklore about the chinook developed **mainly** because chinooks
 - A. were misunderstood
 - B. helped the early settlers
 - C. were a common occurrence
 - D. made the winter more bearable

Andressen, Dolores. “Snow Eater.”
In *Cricket 22*, no. 5 (January 1995).
Adapted and reproduced with
permission from Dolores Andressen.

French Language Arts

Test Description

Part A: Writing consists of two writing assignments—one expressive and one functional—developed to be completed in two hours; however, students may have up to 4 hours to complete the test plus an additional 30 minutes should they need it. For the first 10 minutes of the test time, students have time to discuss both assignments with classmates, in groups of two to four, or to think alone about the writing prompts. Students will engage in this discussion time without teacher participation. During this discussion time, students may record their ideas on the planning pages provided in the test booklet. The allotted test time provides students with time for planning, drafting, and revising both the expressive and functional writing. Students may do their writing using a computer. They may use commercially published dictionaries, bilingual dictionaries, and thesauri, **only** when doing *Part A: Writing*.

Part B: Reading consists of 50 multiple-choice questions based on reading selections from fiction, non-fiction, drama, poetry, and visual media. Students record their answers on a separate, machine-scorable answer sheet. The test is developed to be completed in 60 minutes; however, students have up to 2 hours to complete the test plus an additional 30 minutes should they need it. Students are **not** allowed to use a dictionary, a thesaurus, or other reference material when doing *Part B: Reading*. See *Appendix* for information on new French spelling.

Sample Questions

I. Lis le texte ci-dessous et réponds aux questions 1 à 5.

UN CLOU DÉGUISE EN SOU !

1 Aimes-tu la chimie? Voici une expérience où tu utiliseras la
2 chimie pour nettoyer des pièces de monnaie ternies et pour
3 donner à un clou d'acier l'aspect d'un sou [...].

4 Il te faut :

- un verre transparent
- du vinaigre
- du sel de table
- 4 à 10 pièces de un cent
- deux clous en acier
- du papier d'émeri¹ ou de la laine d'acier
- une cuiller à soupe

1	2	3	4
Dans le verre (ou le bocal), verse environ ½ tasse de vinaigre. Ajoutes-y une cuillerée à table de sel. Brasse avec la cuiller afin de dissoudre le sel.	Frotte un clou avec le papier d'émeri ou la laine d'acier. Le clou doit devenir brillant.	Mets le clou que tu as frotté, ainsi que les pièces de un cent, dans le verre contenant la solution de vinaigre.	Au bout d'environ deux heures, retire le clou et les pièces de monnaie du verre. Compare-les avec des sous et un clou qui n'ont pas trempé dans la solution.

5 Pourquoi les sous deviennent-ils **propres**?

6 Lorsqu'elles sont neuves, les pièces de un cent sont brillantes.
7 Mais avec le temps et au contact de l'air, leur surface se ternit
8 (elle devient noirâtre). En faisant tremper ces pièces dans une
9 solution de vinaigre et de sel, le cuivre terni se détache.
10 Apparaît alors le cuivre qui se trouvait sous cette surface; il est
11 intact et donc, brillant.

12 C'est quoi le **truc**?

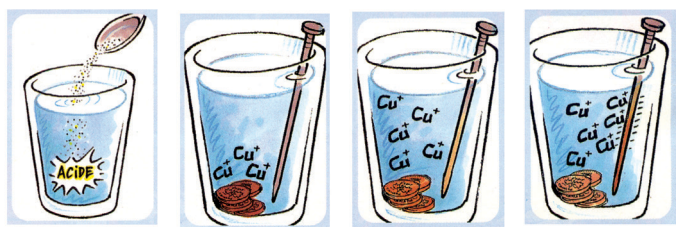

En mélangeant le vinaigre et le sel, il se produit **une réaction chimique** : vinaigre et sel réagissent ensemble et forment **un acide** (de l'acide chlorhydrique).

Cet **acide** attaque les sous noirs, qui sont faits de **particules de cuivre** (Cu+). Ces particules se détachent alors de la surface des pièces de monnaie.

Dans la solution de vinaigre, on trouve maintenant du **cuivre sous la forme d'ions²** (Cu+). C'est-à-dire que les particules de cuivre ont une charge positive.

Les ions cuivre dans la solution sont attirés par le clou d'acier car celui-ci a une charge négative. Au contact du clou, ces ions se collent à l'acier, ce qui lui donne **un aspect cuivré**.

Sarah Perreault
illustrations de Jacques Goldstyn

1. Dans le titre, le mot « DÉGUISE » suggère que le clou

- A. est devenu un nouvel objet
- B. a une apparence différente
- C. a repoussé la saleté
- D. est devenu brillant

2. Dans l'expérience, il faut avoir deux clous pour

- A. montrer le changement de couleur au début et à la fin de l'expérience
- B. brasser le mélange d'ingrédients au début et à la fin de l'expérience
- C. attirer assez de particules de cuivre dans la solution
- D. causer une réaction chimique entre les ingrédients

3. Laquelle des actions suivantes doit-on prendre lors d'une des étapes de l'expérience?

- A. Mélanger le cuivre et l'acide
- B. Séparer le sel du vinaigre
- C. Faire dissoudre le clou
- D. Faire briller le clou

4. Avec le temps, les sous deviennent **moins** brillants à cause

- A. de l'air
- B. du cuivre
- C. de l'acier
- D. du vinaigre

5. Dans l'explication indiquée sous le dernier verre, le clou prend « **un aspect cuivré** » parce que le clou

- A. a attiré les particules d'un autre métal
- B. a changé la couleur de la solution
- C. a transformé la solution en acide
- D. a attiré les particules de sel

Perreault, Sarah. « Un clou déguisé en sou! » *Les Débrouillards*, n° 170 (janvier 1998). Adapté et reproduit avec la permission des Publications BLD inc.

Goldstyn, Jacques. *Les Débrouillards*, n° 170 (janvier 1998). Adapté et reproduit avec la permission de Jacques Goldstyn.

¹papier d'émeri — papier servant à polir (papier sablé)

²ions — molécules

Mathematics / Mathématiques

The Grade 6 Mathematics Achievement Test consists of two parts: Part A and Part B. Students can take a break between the writing of parts A and B. The length of the break is at the discretion of the test administrator.

Test Description

Part A consists of 15 questions and represents approximately 10% of the final overall test score. There are 7 addition/subtraction questions and 8 multiplication/division questions. The format of the questions is numerical-response, which requires students to generate a response (in symbolic form) to a particular problem, rather than selecting a response from a list of four options. Each response will consist of a maximum of 4 digits, or, if a decimal point occurs in the answer, 3 digits. Manipulatives may be used; however, use of a calculator is not permitted when answering the Part A questions.

Part B consists of 40 questions and represents approximately 90% of the final overall test score. The format of the questions is multiple choice, which provides students with four response options of which only one is correct. Manipulatives and a calculator may be used; however, a scientific or graphing calculator is not permitted.

Test items are also categorized in terms of three levels of item complexity: low, moderate, and high. Low-complexity items require responses involving the simple recall and recognition of previously learned concepts and principles. Moderate-complexity items require responses that go beyond the habitual and may require more-informal methods of reasoning and problem solving. High-complexity items require responses that are based on more abstract reasoning, planning, analysis, judgment, and creative thought.

The Grade 6 Mathematics Achievement Test is designed to be administered in 75 minutes; however, students have up to 150 minutes to complete the test plus an additional 30 minutes should they need it. Part A is designed to be administered in 15 minutes, and Part B is designed to be administered in 60 minutes. Teachers have the flexibility to allocate the extra 30 minutes between Part A and Part B as they see fit. For example, a teacher could provide an additional 5 or 10 minutes or more for Part A. The remainder of the additional time can be used for Part B, if needed.

For more information about the Grade 6 Mathematics Achievement Test, view the [*Grade 6 Mathematics Subject Bulletin*](#).

Sample Questions – Part A

Addition

1. What is $4\,905 + 3\,868$?

Answer: _____

2. What is $\$1.50 + \2.45 ?

Answer: \$ _____

3. What is $6.5 + 0.95$?

Answer: _____

4. What is $7 + 0.9 + 1.62$?

Answer: _____

Subtraction

5. What is $70\,365 - 63\,575$?

Answer: _____

6. What is $27.6 - 12.3$?

Answer: _____

7. What is $9.9 - 6.45$?

Answer: _____

8. What is $7 - 4.09$?

Answer: _____

Multiplication

9. What is 15×50 ?

Answer: _____

10. What is 58×72 ?

Answer: _____

11. What is 40.5×2 ?

Answer: _____

*Use the following information
to answer question 12.*

$$950.4 \times 7 = 665__.8$$

12. In the equation above, which digit could be placed in the blank space to make the equation correct?

Answer: **665**__**.8**

Division

13. What is $316 \div 4$?

Answer: _____

14. What is $24.6 \div 2$?

Answer: _____

15. What is $78.03 \div 9$?

Answer: _____

16. What is $3.27 \div 3$?

Answer: _____

Sample Questions – Part B

Use the following information to answer question 1.

Ben is thinking about a certain integer that is:

- less than -5
- greater than -12
- closer to -12 than to -5

1. Which of the following integers could Ben be thinking about?
- A. -4
 - B. -6
 - C. -10
 - D. -14

Use the following information to answer question 2.

Billie arrived at school with two full trays of cupcakes to give to her class. At the end of the day, the two trays were partially full, as shown in the diagram below.

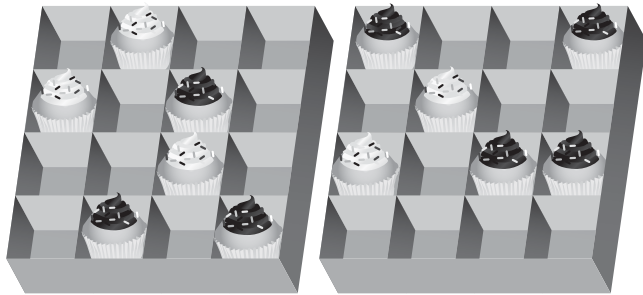

2. Based on the information above, the variable x in the equation $x + 12 = 32$ represents the
- A. total number of cupcakes brought to school
 - B. number of cupcakes in each tray
 - C. cupcakes that were given away
 - D. cupcakes that are left over

Use the following information to answer question 3.

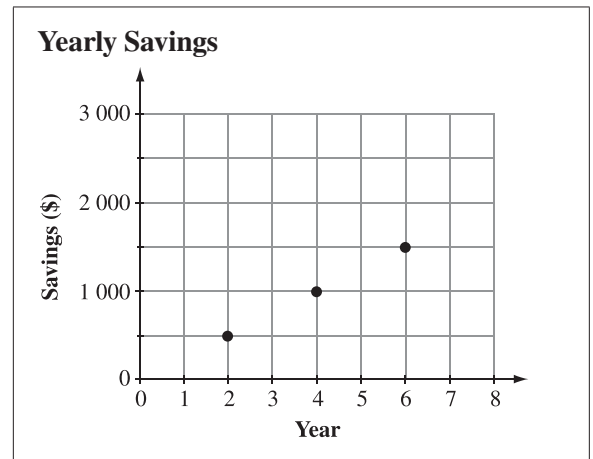

3. If the pattern in the graph continues, then how much money would be saved in year 8?
- A. \$1 500
 - B. \$1 750
 - C. \$2 000
 - D. \$2 250

Use the following information to answer question 4.

Shannon makes 6 grilled-cheese sandwiches for her 4 children. Her oldest child eats 3 sandwiches, and her youngest child eats only $\frac{1}{4}$ of a sandwich.

4. How many sandwiches do Shannon's other 2 children eat if all the sandwiches are eaten?
- A. $2\frac{3}{4}$
 - B. $2\frac{1}{4}$
 - C. $1\frac{3}{4}$
 - D. $1\frac{1}{4}$

Use the following information to answer question 5.

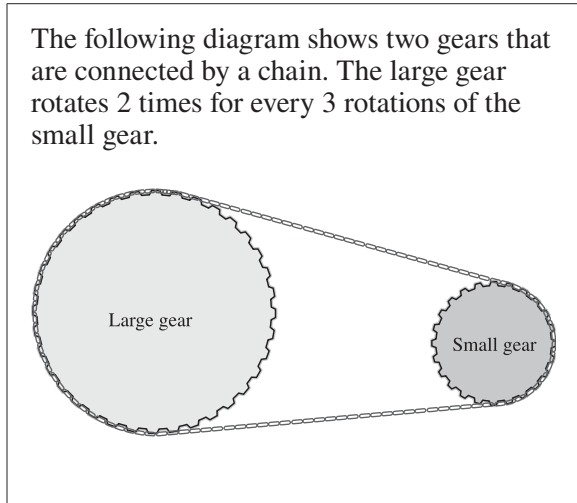

5. What is the total number of rotations of **both** gears when the large gear rotates 36 times?
- A. 54 rotations
 - B. 60 rotations
 - C. 72 rotations
 - D. 90 rotations

Use the following information to answer question 6.

Louise charges \$5 per hour for babysitting one child and \$1.25 per hour for each additional child.

6. How much would Louise charge to babysit 4 children for 6 hours?
- A. \$30.00
 - B. \$37.50
 - C. \$52.50
 - D. \$60.00

Use the following information to answer question 7.

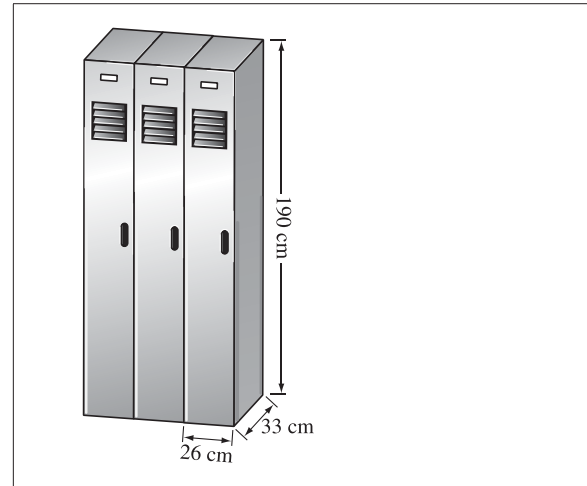

7. Which of the following expressions can be used to find the total volume of the 3 lockers?
- A. $(26 \text{ cm} \times 33 \text{ cm} \times 190 \text{ cm}) \times 3$
 - B. $(26 \text{ cm} + 33 \text{ cm} + 190 \text{ cm}) \times 3$
 - C. $(26 \text{ cm} \times 33 \text{ cm} \times 190 \text{ cm}) \div 3$
 - D. $(26 \text{ cm} + 33 \text{ cm} + 190 \text{ cm}) \div 3$

Use the following information to answer question 8.

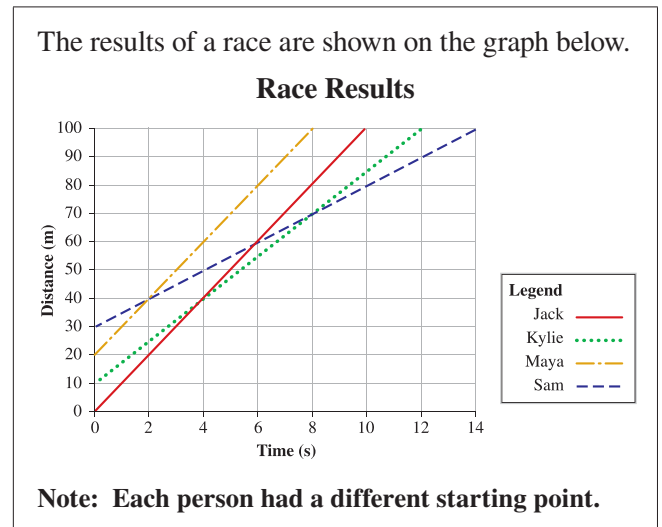

8. Which two people each ran 40 metres in 4 seconds?
- A. Sam and Kylie
 - B. Kylie and Jack
 - C. Jack and Maya
 - D. Maya and Sam

Science / Sciences

Test Description

The Grade 6 Science Achievement Test consists of 50 multiple-choice questions. The test is developed to be completed in 1 hour; however, students have up to 2 hours to complete the test plus an additional 30 minutes should they need it. Students record their answers on a tear-out, machine-scorable answer sheet. Test items are created from the student outcomes contained within each of the following five strands of the Alberta Program of Studies for Grade 6 Science: Inquiry and Problem Solving; Air, Aerodynamics, and Flight; Sky Science; Evidence and Investigation; and Trees and Forests.

For more information on test administration, view the [Grade 6 Science Subject Bulletin](#).

Sample Questions

Use the following information to answer question 1.

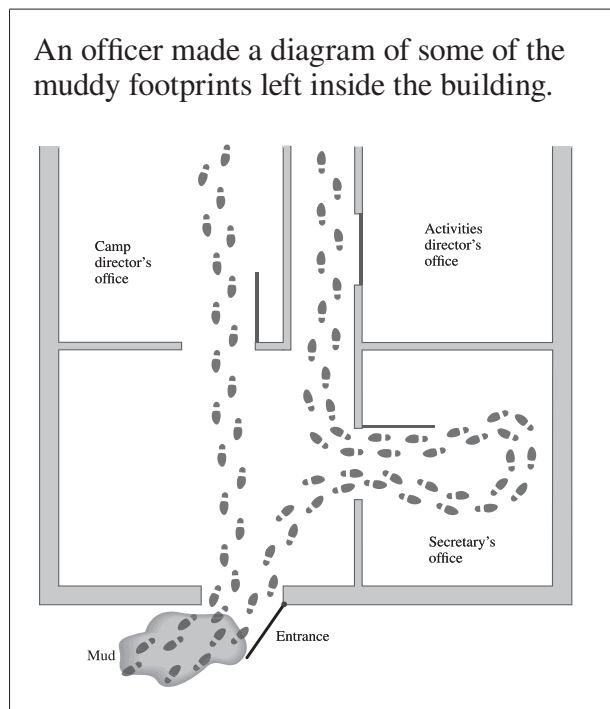

1. By looking at the officer's diagram, it can be inferred that the person who left the footprints
 - A. stayed in the building only a few seconds
 - B. triggered an alarm in the secretary's office
 - C. ran out of the building carrying something heavy
 - D. found a second door leading to the camp director's office

Use the following information to answer question 2.

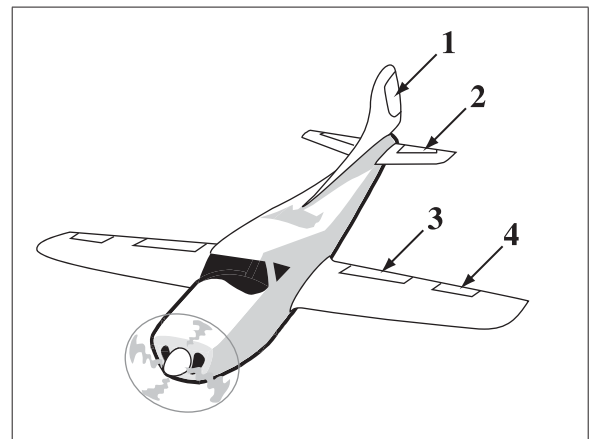

2. The part of the airplane shown above that causes the nose to tilt down and the tail to rise is numbered
 - A. 1
 - B. 2
 - C. 3
 - D. 4

Use the following information to answer question 3.

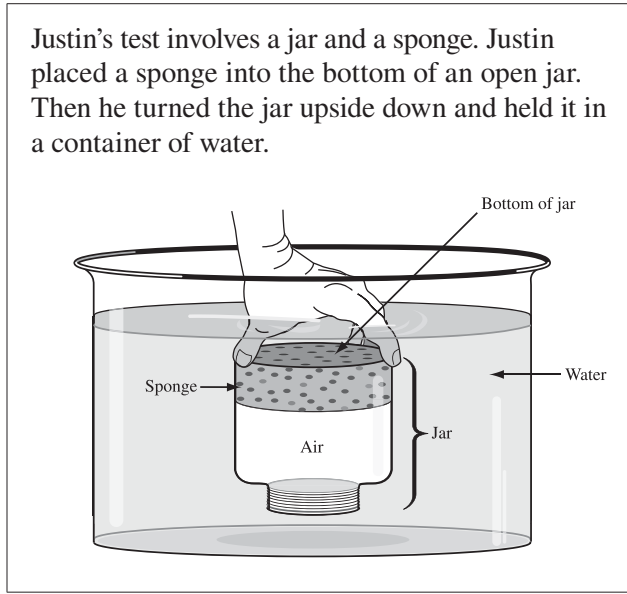

3. Which of the following statements explains why the sponge did not get wet?
- A. The air in the jar exerts pressure on the water.
 - B. The air in the jar is lighter than the sponge.
 - C. The sponge is lighter than the air.
 - D. The sponge takes up space.

Use the following information to answer question 4.

Henri's investigation showed how the length of a shadow cast by a sundial changed throughout the day.

4. Henri explained that the length of the sundial's shadow changed throughout the day because of the
- A. revolution of Earth around the Sun
 - B. distance of Earth from the Sun
 - C. rotation of Earth on its axis
 - D. tilt of Earth on its axis

Use the following information to answer question 5.

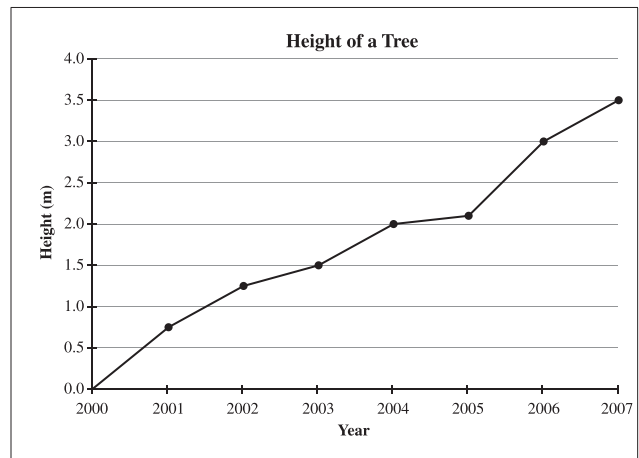

5. Between which years was the tree's growth **most** affected by good growing conditions?
- A. 2001 and 2002
 - B. 2003 and 2004
 - C. 2004 and 2005
 - D. 2005 and 2006

Social Studies / Études Sociales

Test Description

The Grade 6 Social Studies Achievement Test consists of 50 multiple-choice questions. The test is developed to be completed in 60 minutes; however, students have up to 2 hours to complete the test plus an additional 30 minutes should they need it.

Sample questions will be posted on the [Alberta Education website](#).

For more information, see the [Grade 6 Social Studies Subject Bulletin](#).

Sample Questions

Use the following information to answer question 1.

Events in the Electoral Process

- 1 People who are eligible to vote cast their votes at polling stations.
- 2 Candidates campaign in an attempt to win people's votes.
- 3 The premier visits the lieutenant governor and asks for the session of the legislature to be dissolved.
- 4 The premier calls an election.
- 5 Elected officials are sworn in as members of the government.

1. Which of the following sequences identifies the correct order of events in a provincial electoral process?
 - A. 5, 1, 2, 3, 4
 - B. 2, 3, 4, 1, 5
 - C. 4, 2, 3, 5, 1
 - D. 3, 4, 2, 1, 5
2. The citizens of Ancient Athens took action against individuals who did not vote most likely because they believed that
 - A. obedience was more important than freedom
 - B. public life was more important than family life
 - C. citizens had the right to participate in government
 - D. citizens had the responsibility to participate in government
3. Some agreements and treaties were recorded by oral tradition and by
 - A. sketching pictures on paper
 - B. weaving a wampum belt
 - C. writing on birch bark
 - D. creating a myth

Answers to Sample Questions

<i>English Language Arts</i>	<i>French Language Arts</i>	<i>Mathematics/ Mathématiques</i>	<i>Science/ Sciences</i>	<i>Social Studies/ Études Sociales</i>
1 B	1 B	<i>Part A</i>	1 D	1 D
2 C	2 A	1 8773 9 750	2 B	2 D
3 A	3 D	2 3.95 10 4176	3 A	3 B
	4 A	3 7.45 11 81.0 or 81	4 C	
	5 A	4 9.52 12 2	5 D	
		5 6790 13 79		
		6 15.3 14 12.3		
		7 3.45 15 8.67		
		8 2.91 16 1.09		
		<i>Part B</i>		
		1 C 5 D		
		2 C 6 C		
		3 C 7 A		
		4 B 8 C		

Contacts

If you have additional questions or comments about achievement testing, please speak with your child's teacher or school principal, or contact:

Nicole Lamarre, Director
 Student Learning Assessments and
 Provincial Achievement Testing
 780-427-6204
Nicole.Lamarre@gov.ab.ca

To be connected toll-free in Alberta, dial 310-0000.

Appendix

New French Spelling

As of January 2008, all French Alberta Education documents have been published in accordance with the new spelling rules adopted by the *Conseil supérieur de la langue française* of France in 1990.

These new rules apply to approximately 2,000 words in the French language. Even though these new rules have been officially approved, they are not mandatory. During this transition period, which could last many years, both spellings are admitted. Neither spelling, traditional or new, is wrong. Consequently, no student who uses either spelling convention, even within a given written assignment, is to be penalized. This holds true for all school work as well as for all written responses in the provincial French achievement tests and diploma exams.

The key new rules follow:

- 1. The elements of compound numbers are all joined by a hyphen.**
 - a. Traditional spelling: deux cent quarante-sept
 - b. New spelling: deux-cent-quarante-sept
- 2. The circumflex accent is no longer used on *i* and *u*.**
 - a. Traditional spelling: connaître, coûter, août, maîtrise
 - b. New spelling: connaitre, couter, aout, maîtrise
- 3. The grave accent replaces the acute accent before a syllable having a *silent e*.**
 - a. Traditional spelling: événement, crémerie, céleri
 - b. New spelling: évènement, crèmerie, cèleri
- 4. The hyphen is removed from compound words having a prefix such as *entre-*, *contre-* and in words borrowed from other languages.**
 - a. Traditional spelling: entre-temps, contre-exemple, auto-école, basket-ball
 - b. New spelling: entretemps, contrexemple, autoécole, basketball
- 5. The second element of compound words is now pluralized when the word is used in the plural.**
 - a. Traditional spelling: des brise-glace, des cure-dent, des après-midi
 - b. New spelling: des brise-glaces, des cure-dents, des après-midis

The following page shows an example taken from past achievement tests in mathematics.

Grade 6 — Removal of the circumflex accent

Traditional spelling

Utilise l'information suivante pour répondre à la question 39.

L'école loue un autobus pour transporter les élèves entre l'école et le centre de plein air. La distance entre l'école et le centre de plein air est de 335,85 km. La compagnie d'autobus demande un prix de 0,85 \$ du kilomètre pour les 90 premiers kilomètres, et un prix de 0,75 \$ pour chaque kilomètre qui dépasse les 90 premiers kilomètres.

39. Combien coûte un **aller simple** jusqu'au centre de plein air?
- A. 260,89 \$
 - B. 285,47 \$
 - C. 521,78 \$
 - D. 570,95 \$

New spelling

Utilise l'information suivante pour répondre à la question 39.

L'école loue un autobus pour transporter les élèves entre l'école et le centre de plein air. La distance entre l'école et le centre de plein air est de 335,85 km. La compagnie d'autobus demande un prix de 0,85 \$ du kilomètre pour les 90 premiers kilomètres, et un prix de 0,75 \$ pour chaque kilomètre qui dépasse les 90 premiers kilomètres.

39. Combien **coute** un **aller simple** jusqu'au centre de plein air?
- A. 260,89 \$
 - B. 285,47 \$
 - C. 521,78 \$
 - D. 570,95 \$